

# John Meunier Products Grit Removal System

## A long tradition in excellence

John Meunier products have been serving North American municipalities and industries since 1948.

With a wide range of technologies, we design, manufacture and service wastewater treatment plants, offering complete solutions with a wide range of highly efficient screening and grit removal equipment.

There are more than fifteen hundred units installed across North America.

# Grit in Wastewater Applications



Grit is a source of problems in wastewater treatment facilities. It consists of inert and organic abrasive particles which are between 50 and 200 MESH (300 and 75  $\mu\text{m}$ ) in diameter and have a specific gravity of approximately 2.65.

Grit is known to cause wear and tear on mechanical equipment, reduce the effective treatment volume in basins, and increase the occurrence of pipe blockages.

Historically, rectangular aerated grit removal systems were very large, resulting in high land, civil and equipment costs.

Since the early 1980s, Veolia Water Technologies Canada has been offering complete grit removal systems, which feature the MECTAN<sup>®</sup> vortex grit chamber technology.

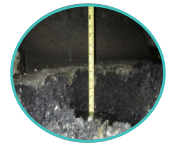

## Overview of Veolia Grit Removal System

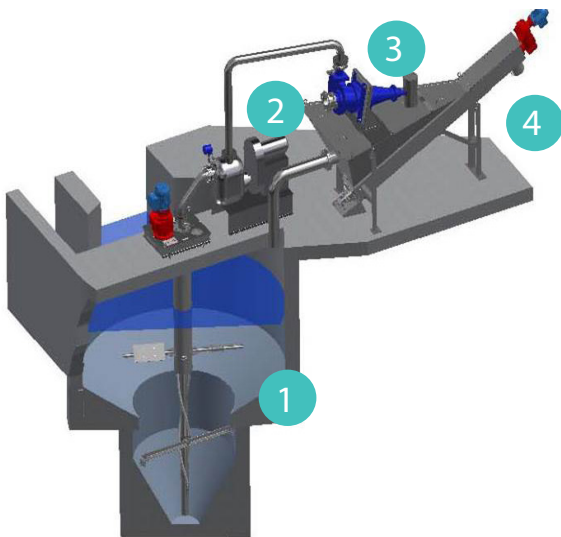

Veolia offers a fully integrated, highly efficient, grit removal system that operates based on the following grit removal process:

Step 1: Grit capture

Step 2: Grit extraction

Step 3: Grit concentration

Step 4: Grit washing and dewatering

Grit Capture in the Veolia system is achieved through the use of the MECTAN<sup>®</sup> Grit Chamber. The MECTAN<sup>®</sup> grit chamber is available in several configurations that each incorporate a circular top chamber where the vortex is created and a bottom grit well for grit collection. The circular chamber is designed to handle large flow rates in a fraction of the footprint of conventional aerated degritters.

Once the grit has been captured in the grit well, the grit slurry is extracted with a grit pump or an airlift system. The grit pump can be installed in a top mounted or bottom suction configuration. The airlift system can only be installed in the top mounted configuration and is limited to smaller applications. Once the grit slurry, which contains a high water content, is extracted, the grit and water are separated by a hydrocyclone (grit pump extraction) or an air separator (airlift system). The concentrated grit slurry is discharged into the SAM<sup>®</sup> type GDS Grit Dewatering Screw which further cleans the grit and reduces water content. The overflows from the grit separator and grit classifier are returned upstream of the grit chamber.

# MECTAN® Vortex Grit Chambers

## MECTAN® Classic Vortex Grit Chamber

The MECTAN® C (270) unit takes full advantage of the tangential inflow velocity along the periphery of the chamber to initiate the grit separation process. The reliable system operates efficiently over a wide range of daily flow rates with low head loss as a result of the open channel design. The top chamber sloped transition along with the rotating motion eliminates accumulation of grit in the uppermost separation chamber under all conditions and maintains grit removal performances even during a power failure.

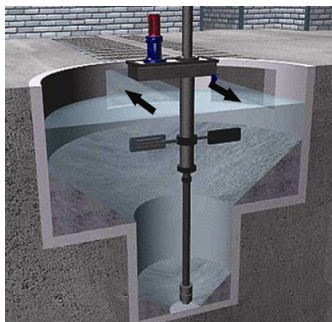

## MECTAN® V Vortex Grit Chamber

The MECTAN® V (Variangle) unit, launched in 2009, is an innovative re-engineering of the Classic MECTAN® technology. The concept capitalizes on the classic tank geometry to enhance the effective conical transition between chamber sections to obtain a dynamic and revolutionary configuration. The use of a separation disc ensures process stability and reliability at any flow rate with a 20% overall increase in grit capture efficiency, mainly in fine particles. With its multi-directional outlet channel positioning capability, the Variangle unit provides wastewater treatment plant layout flexibility.

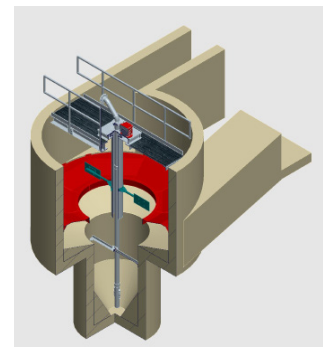

*Patent Nos.  
CA2743003 and  
US871551*

## BioMECTAN® Advanced Hybrid Vortex Grit Removal System

The BioMECTAN® is the latest addition to the Grit Removal System product line. Based on the MECTAN® V tank geometry and hydraulic concepts, the BioMECTAN® includes additional internal baffles which further promote grit settling and capture, to ultimately increase the overall system performance. High shear mixing zones are created through the use of eductors, which separate organics from the grit particles and keep organics in suspension, eliminating the need for paddles. The BioMECTAN® is a more environmentally-conscious solution that uses gray water instead of potable water for grit fluidization. There are no moving parts below the water level, thus reducing maintenance requirements.

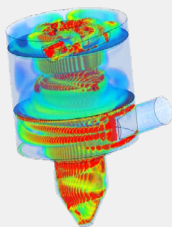

The BioMECTAN® is available in self-standing stainless steel tanks, includes standard piped inlet and outlet connections, and features a 360+ outlet pipe configuration. Although the inlet must be submerged and tangential to the tank walls, the outlet pipe can be positioned anywhere along the tank circumference, above the baffle system, further increasing the site layout possibilities.

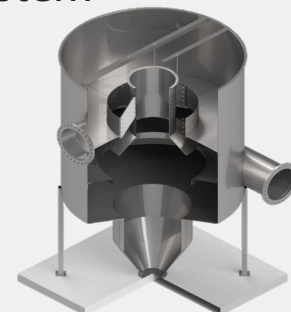

*Patent Pending No. 62/701,976*

### Available Options:

- 1 Integral Emergency Bypass System: The MECTAN® V and BioMECTAN® can include a built-in overflow that has a bypass capability up to 25% in excess of the unit's maximum rated capacity, while slightly reducing overall performance during an overflow event.
- 2 Reduced Potable Water Consumption: Gray water re-use systems are available for the Mectan® fluidization system and the SAM® type GDS Grit Dewatering Screw optional washing system.

# MECTAN® Vortex Grit Chambers

## Product Characteristics

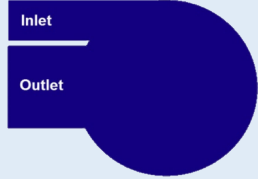
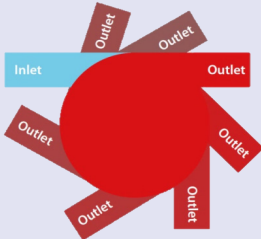
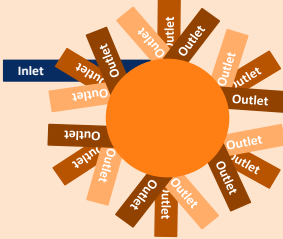
	MECTAN® C	MECTAN® V	BioMECTAN®
Inlet Channel	Open	Submerged	Submerged
Inlet and Outlet Channel Configurations			
Headloss Created	¼ inch	Up to 4 inches	Up to 8 inches
Organics Separation	Average	Average	High
Concrete Installation	✓	✓	✗
Self-Standing Tank	✓	✓	✓
Increased Flow Capacity	✗	✗	✓

## Model Sizing

Model	0-12	1-20	2-25	3-30	4-35	5-42	6-50	7-60	8-73	
<b>Diameter</b>	48" [1200 mm]	78" [2000 mm]	102" [2500 mm]	120" [3000 mm]	138" [3500 mm]	168" [4200 mm]	198" [5000 mm]	240" [6000 mm]	288" [7300 mm]	
<b>Maximum Flow</b>	<b>MECTAN® C and MECTAN® V</b>	0.8 MGD* [3.03 MLD]	2.5 MGD [9.5 MLD]	4.3 MGD [16.3 MLD]	7.2 MGD [27.3 MLD]	10.7 MGD [40.5 MLD]	18.7 MGD [70.8 MLD]	30 MGD [113.6 MLD]	50 MGD [189.25 MLD]	78.0 MGD [295.25 MLD]
	<b>BioMECTAN®</b>		3.1 MGD [11.7 MLD]	5.4 MGD [20.4 MLD]	9 MGD [34.1 MLD]	13.4 MGD [50.7 MLD]				

Note: Model 0-12 in a concrete installation is only available for the MECTAN® C grit chamber configuration

## Performances

Veolia Grit Removal systems are sized based on the application peak flow. There is no minimum flow required to operate the MECTAN® grit chamber. Grit removal performances increase as the flow rate in the system decreases since the velocity across the grit chamber is lower, which increases retention time and promotes particle settling. The stated performances are based on typical municipal wastewater grit distribution (weight/million gallons of water).

Grit Removal Efficiency (2.65 S.G.)				
TYPE	PARTICLE SIZE			
	≥ 50 Mesh (≥ 300 µm)	≥ 70 & < 50 Mesh (≥ 210 & < 300 µm)	≥ 100 & < 70 Mesh (≥ 150 & < 210 µm)	≥ 140 & < 100 Mesh (≥ 100 & < 150 µm)
<b>MECTAN® C</b>	95 %	85%	65%	38%
<b>MECTAN® V</b>	96%	87%	75%	68%
	95% grit removal down to 140 Mesh (100 µm)			
<b>BioMECTAN®</b>	95% grit removal down to 200 Mesh (75 µm)			

# Grit Removal System

## SAM<sup>®</sup> type GDS Grit Dewatering Screw



The SAM<sup>®</sup> type GDS Grit Dewatering Screw provides the final separation between grit and water. This is achieved through the use of an inclined spiral installed in a uniquely shaped trough. The concentrated grit slurry is fed to the inlet hopper where grit classification and settling is achieved. The excess water overflows back to the influent channel. The slow rotation of the screw causes the grit to dewater as it moves toward the discharge point. The unit is supplied with an air separator or hydrocyclone separator according to the feed mean used. This pre-assembled unit can eliminate problems associated with foul odor and unsanitary handling.

## Grit Removal Combined Unit

The Grit Removal Combined unit is an integral grit removal system that can accommodate flows up to 30,000 m<sup>3</sup>/d (7.925 MGD). These systems are fabricated in enclosed self-standing stainless steel tanks, which reduces the overall required civil work and provides a certain amount of odour control. The Grit Removal Combined units are available for the MECTAN<sup>®</sup> V (360°) Grit tank configuration.

A pumping system is not required as the captured grit is deposited by gravity directly into the lower SAM<sup>®</sup> Grit Dewatering Screw.



## Control System



Dedicated control system with Intelligent programmable relay (Zelio) or PLC with HMI. All automatic sequences of operation, manual operation, protections and alarms included. Local control station for tests and maintenance (if applicable). Standard control system and custom system upon client standards are available. Design and engineering by Veolia.

## On-Site Testing

Veolia offers full-scale on-site grit removal sampling and testing, in accordance with the latest published wet and dry sieving test methods. Sampling is performed with MultiPoint Integrated Samplers that are designed to collect representative samples simultaneously across the entire flow cross-section in the inlet and outlet channels respectively. The samples are pumped to grit collection settling tanks. Once a sufficient grit volume has been collected, the collected samples will undergo grit characterization analysis to evaluate performances.



# The Complete John Meunier Headworks Set-up

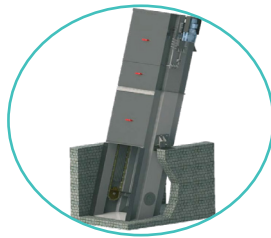
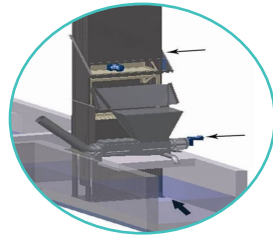
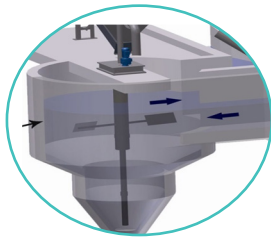
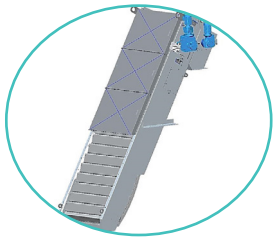

Coarse and Fine Screens, bar type  
CONT-FLO® type CF Vertical Bar Screen  
CONT-FLO® type ER Multi-Rake Bar Screen

Fine Screens, mobile screening plate type  
ESCALATOR® Fine Screen  
ROTARC® type SD Rotary Drum Fine Screen

Fine Screens, stationary screening plate type  
ROTARC® type SB Shaftless Spiral Fine Screen

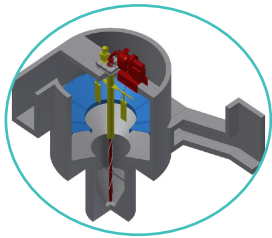

## Solids' Handling

ROTOPAC® type RPW Screw Washer Compactor  
ROTOPAC® type RCW Dual-Stage Screw Washer Compactor  
ROTOPAC® type RDW Shaftless Screw Compactor  
ROTOPAC® type RLK Screw Conveyor

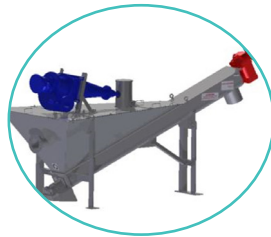

## Grit Removal Systems

MECTAN® Vortex Grit Removal System  
SAM® type GDS Grit Dewatering Screw  
SAM® type GFW Grit Washer

## Combined Systems

SEPRAPAC® type PCS Pretreatment Combined System  
SEPRAPAC® type SRS/SCS Septage Combined System

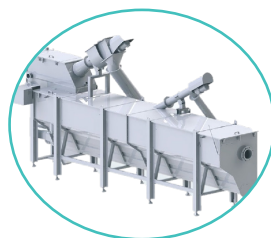
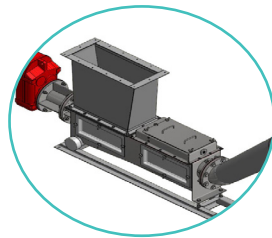

Veolia Water Technologies Canada is the final choice for the design, manufacture and servicing of wastewater pretreatment works. We target excellence and innovation. We also invest in R&D to meet growing environmental regulations and market needs.

### Quebec

4105 Sartelon  
St-Laurent, Quebec  
H4S 2B3 - Canada  
T : 514 334 7230  
F : 514 334 5070

### Offices

### Ontario

2000 Argentia Road  
Plaza IV, suite 430  
Mississauga, ON  
L5N 1W1 - Canada  
T : 905 286 4846  
F : 905 286 0488

# Resourcing the world

Veolia Water Technologies

4105 Sartelon • St-Laurent, Quebec • H4S 2B3 Canada

tel: 514-334-7230 • fax: 514-334-5070

[sales@veolia.com](mailto:sales@veolia.com) • [www.veoliawatertechnologies.ca](http://www.veoliawatertechnologies.ca)